

Precautions

1. Keep and store the product away from the reach of children.
2. Check the component list and condition of the product before installation. If there is any problem, contact the shop where you purchased to get a replacement or refund.
3. RAIJINTEK Co., Ltd. is not responsible for any damages due to external causes, including but not limited to, improper use, problems with electrical power, accident, neglect, alteration, repair, improper installation, and improper testing.

4. GPU and VGA card are subject to damage if the product is incorrectly installed.
5. This product is a water cooling solution device, once taken apart or any use of non RAIJINTEK's accessories, will lead to a warranty loss.
6. Liquid contaminations of other objects are in no matter under warranty due to maintenance or possible misuse.

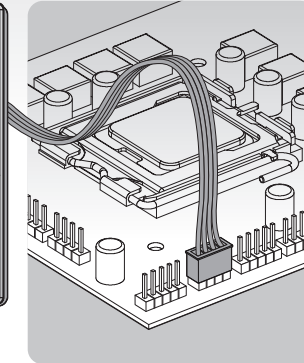
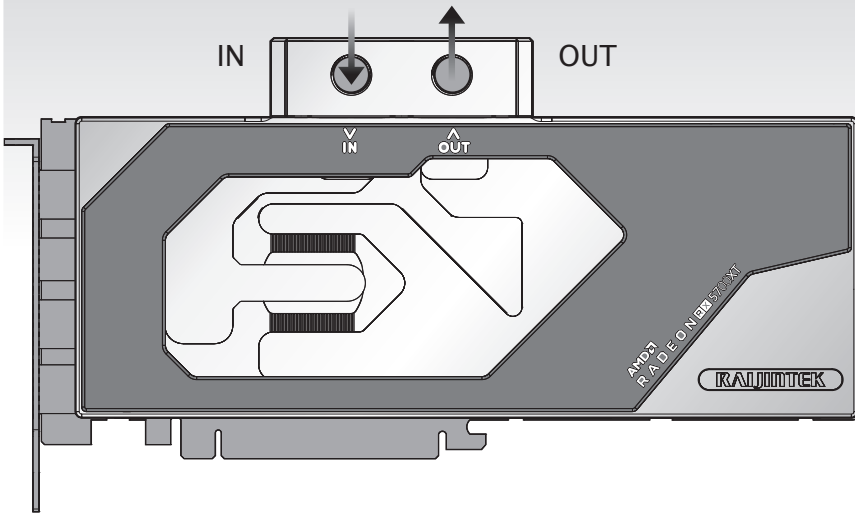

Connect to MB 5V ADD Header

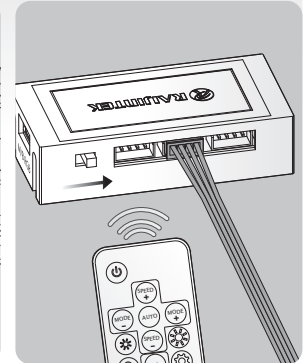

Connect to RJK RBW-ADD Control Hub

A VGA water block × 1

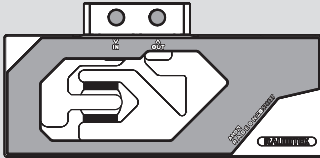

B Back plate × 1

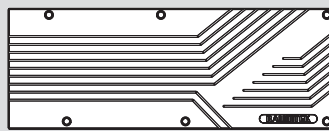

C Thermal Grease × 1

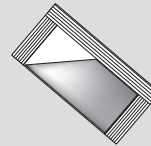

D Thermal pad × 4



E Washers × 15

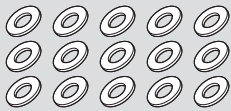

F M2 L6 screw × 10



G M2 L10 screw for back plate × 6

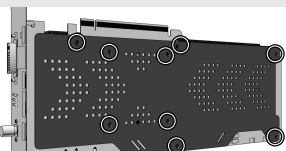

Remove the screws circled on the diagram. All Back-plate and Heat-sink assembly screws should be removed

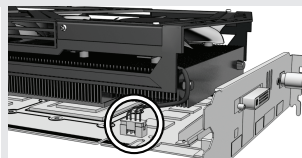

Remove the power connector of fan, and carefully detach the original stock cooler

1

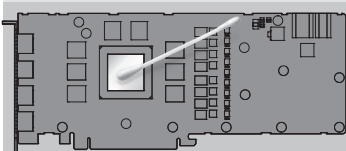

Clean the original thermal grease off the GPU die and thermal pad.

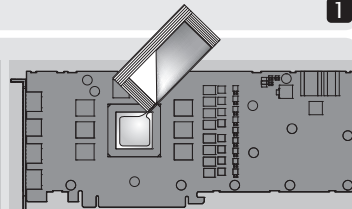

Apply Thermal grease on GPU evenly.

2

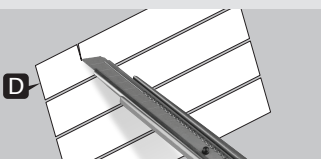

Cut the thermal pads to place on the heat-emitting chips.

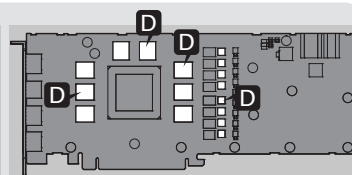

! Precaution: Besides GPU that needs to have thermal grease applied on it, the heat emanating chip on the VGA card also needs the thermal pads to be attached on it, or the card will burn out.

3

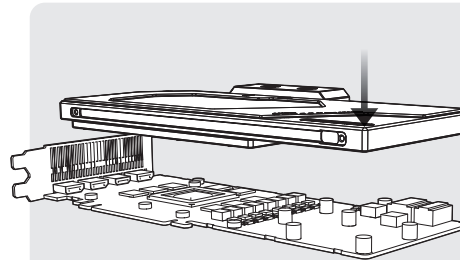

Stick the VGA water block on the VGA card. Align the screws onto the screw holes on the VGA card. Pay attention to the pressure applied during installation. Do not press the VGA water block and PCB board too hard.

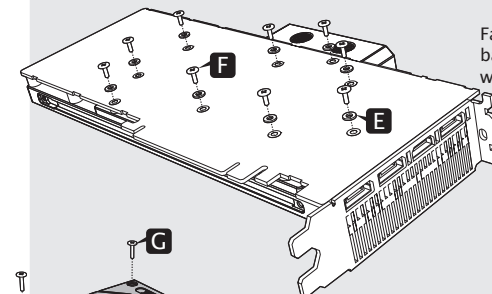

Fasten the spring screw from backside (Place the insulation washer on the screw hole)

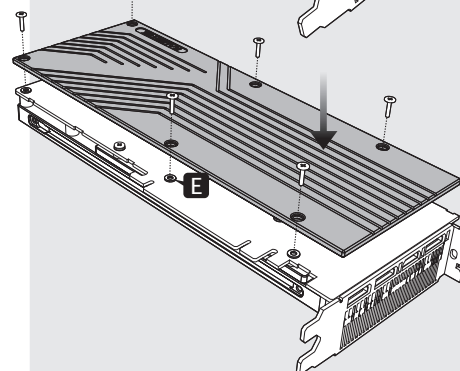

Once installing VGA water block is done, place the back plate and fasten the screws on it.

! Precaution: Fasten the screws until the VGA water block is balanced. To avoid damaging the chip, do not fasten the screws to the point where it cannot be screwed anymore.

4